



Hefei Hefu Intelligent Energy Co.,Ltd



6th floor, G3 Building B, Hefei Software Park Phase II



+86 (0)551 8266-6766



www.hfiepower.com



hfiepower@hfiepower.com



Hefei Hefu Intelligent Energy Co.,Ltd

Contents

1. About This Manual	1
1.1 Scope of Validity	1
1.2 Target Group	1
2. Safety & Symbols	1
2.1 Safety Precautions	1
2.2 Explanations of Symbols	2
3. Introduction.	3
3.1 Basic Instruction	3
3.2 Operation Modes	3
3.2.1 SelfUse	3
3.2.2 ChgFst	4
3.2.3 SellFst	4
3.2.4 Maintain	5
3.2.5 cdmChg	5
3.2.6 ExtEms	6
3.2.7 PeakShave	6
3.2.8 Time of Use	6
4. Installation.	9
4.1 Pre-installation	9
4.1.1 Unpacking & Package List	9
4.1.2 Product Overview	10
4.1.3 Mounting Location	11
4.2 Mounting	13
4.3 Electrical Connection	14
4.3.1 PV Connection	15
4.3.2 Battery Connection.	16
4.3.2.1 BAT-CAN/RS485.	19
4.3.3 AC Connection.	20
4.3.4 CT or Meter Connection	22
4.4 Communication Connection	23
4.5 Earth Connection	24
4.6 Multi Inverter Parallel	25

5. Operation	26
5.1 Control Panel	26
5.2 Menu Overview	27
5.3 Control Panel	27
5.3.1 Time & Date	28
5.3.2 Safety	28
5.3.3 Lithium Battery	29
5.3.4 PV Mode	29
5.3.5 Lead Acid	30
5.3.6 Energy Management System (EMS Param)	30
5.3.7 Timing of Use	31
5.3.8 AC Charging	32
5.3.9 Forced Charging	32
5.3.10 Forced Discharging.	33
5.3.11 Protection Parameters	34
5.3.12 Multi-machine in Parallel	35
5.3.13 Diesel Generator Setting (Diese1 Gen Param)	35
6. Power ON/OFF	36
6.1 Power ON	37
6.2 Power OFF	37
6.3 Restart	37
7. Maintenance & Trouble Shooting	37
7.1 Maintenance	37
7.2 Trouble Shooting	37
8. Specifications	50

1. About This Manual

1.1 Scope of Validity

This manual mainly describes the product information, guidelines for installation, operation, maintenance and troubleshooting. And this manual applies to HFIE Three phase Hybrid Inverter.

AF3K-TH AF4K-TH AF5K-TH AF6K-TH AF8K-TH AF10K-TH
AF12K-TH AF15K-TH AF17K-TH AF20K-TH AF25K-TH AF30K-TH

Please keep this manual available all the time in case of any emergency.

1.2 Target Group

This manual is for qualified personnel. The tasks described in this manual must only be performed by qualified personnel.

2. Safety & Symbols

2.1 Safety Precautions

1. All work on the inverter must be carried out by qualified electricians.
2. The PV panels and inverter must be connected to the ground.
3. Do not touch the inverter cover until 5 minutes after disconnecting both DC and AC power supply.
4. Do not touch the inverter enclosure when operating, keep away from materials that may be affected by high temperatures.
5. Please ensure that the used device and any relevant accessories are disposed of in accordance with applicable regulations.
6. HFIE inverter should be placed upwards and handled with care in delivery. Pay attention to waterproof. Do not expose the inverter directly to water, rain, snow or spray.
7. Alternative uses, modifications to the inverter not recommended. The warranty can become void if the inverter was tampered with or if the installation is not in accordance with the relevant installation instructions.

2.2 Explanations of Symbols

HFIE inverter strictly comply with relevant safety standards. Please read and follow all the instructions and cautions during installation, operation and maintenance.



Danger of electric shock

The inverter contains fatal DC and AC power. All work on the inverter must be carried out by qualified personnel only.



Beware of hot surface

The inverter's housing may reach uncomfortably hot 60°C (140°F) under high power operation. Do not touch the inverter enclosure when operation.



Residual power discharge

Do not open the inverter cover until 5 minutes after disconnection both DC and AC power supply.



Important notes

Read all instructions carefully. Failure to follow these instructions, warnings and precautions may lead to device malfunction or damage.



Do not dispose of this device with the normal domestic waste.



Refer to manual before service.

3. Introduction

3.1 Basic Instruction

The HFIE AF-TH Three phase Hybrid Inverters are designed to increase energy independence for homeowners. Energy management is based on time-of-use and demand charge rate structures, significantly reduce the amount of energy purchased from the public grid and optimize self-consumption.

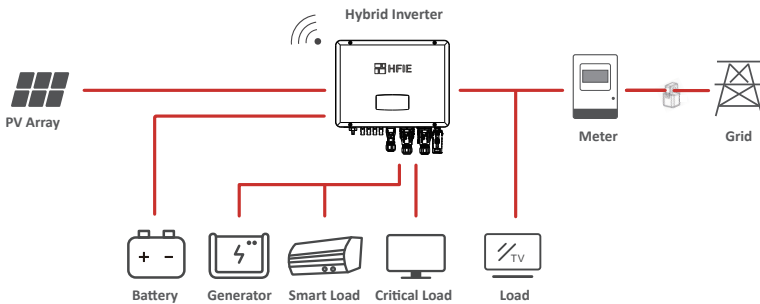

3.2 Operation Modes

3.2.1 SelfUse

The SelfUse mode is for the regions with low feed-in tariff and high electricity prices. The energy produced by the PV system is used to optimize self-consumption needs. The excess energy is used to recharge the batteries, any remaining excess is then exported to the grid.

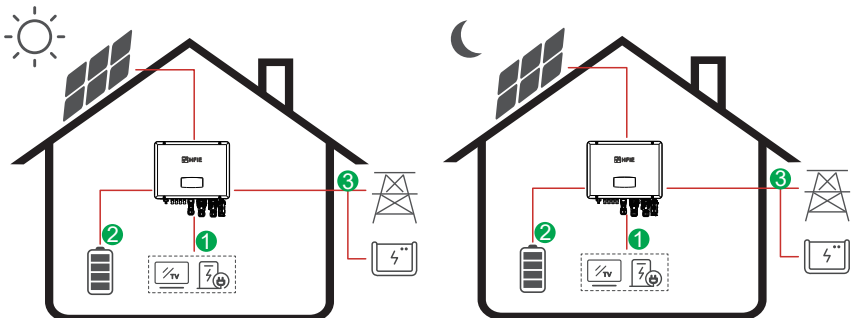

Energy flow:

PV → Load → Battery → Grid

Note: Advance Setting

When select 0 W under P_Feed menu, the inverter will export zero energy to the grid.

When select xx W under P_Feed menu, the inverter will export customized energy to the grid.

3.2.2 ChgFst

When the grid fails, the system will automatically switch to ChgFst mode. The back-up loads can be supplied by both PV and battery energy.

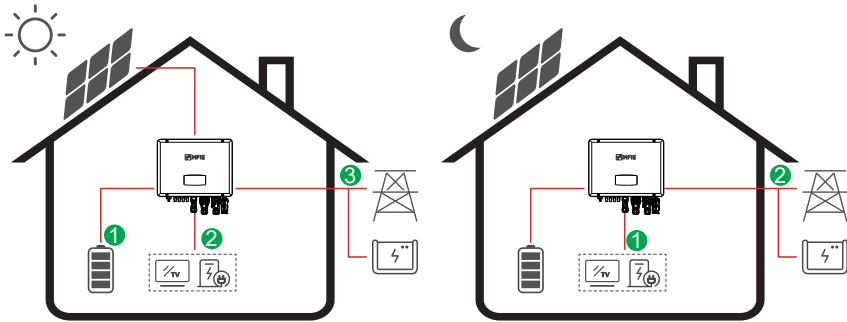
Energy flow: PV → Battery → Load → Grid

3.2.3 SelfFst

The SelfFst mode is suitable for the regions with high feed-in tariff.

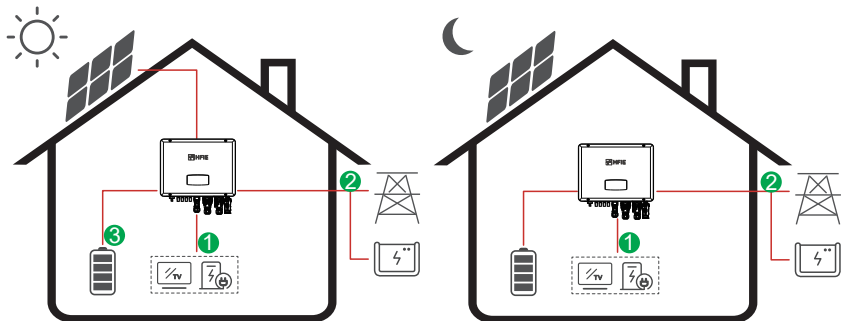
Energy flow:

PV → Load → Grid → Battery

3.2.4 Maintain

The Maintain mode is suitable for situations where the battery capacity is small, and the battery is charged and discharged at the specified power.

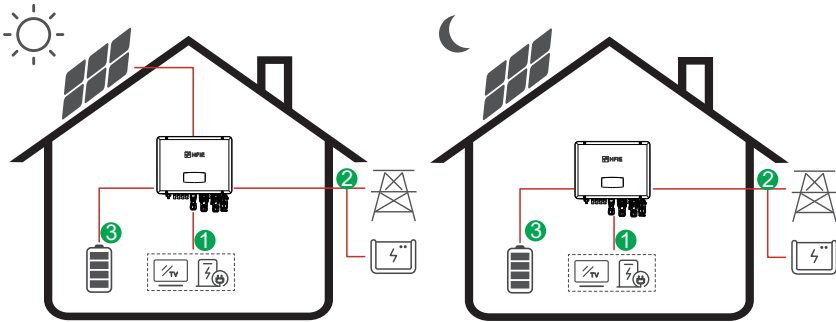

Energy flow:

PV → Load → Grid → Battery



Warning:

The Maintain mode is only available for some inverter.

3.2.5 cmdChg

In cmdChg mode, within the battery power range, the battery is charged and discharged at the specified power.

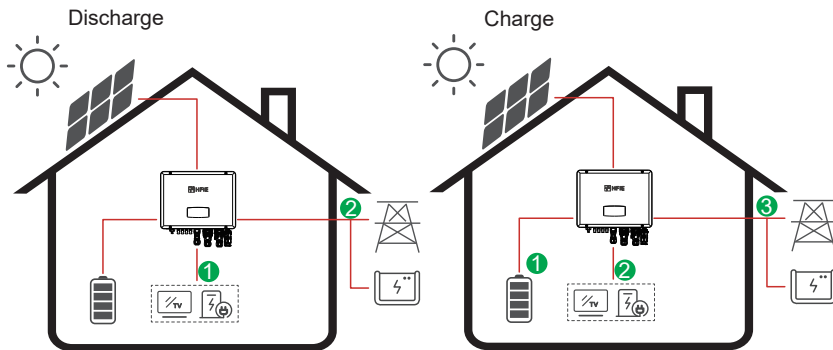

Energy flow:

Discharge: Battery and PV → Load → Grid

Charge: $P_{PV} > P_{Charge\ Set}$: PV → Battery → Load → Grid

$P_{PV} < P_{Charge\ Set}$: PV+Grid → Battery → Load

3.2.6 ExtEms

ExtEms mode requires customized external control accessories that can remotely control the operation of the inverter. It is not recommended to use it without professional personnel.

3.2.7 PeakShave

In PeakShave mode, the charging and discharging of the battery are controlled by setting the AC power to reduce the peak load of the power grid.

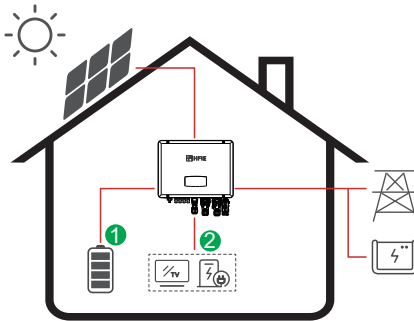

Energy flow: Grid power > P_Back : Battery and PV → Load
 Grid power < P_Back : Grid and PV → Battery



Note:

P_Back is set to Grid Ctr1 in the Run Param directory of the menu.

3.2.8 Time of Use

The Time of Use mode is designed to reward customers who do their part to reduce demand on the electric grid, particularly during peak usage periods. Use most of your electricity from PV energy and during off-peak time periods, and you could significantly lower your monthly bill.

A. Charge Setting

PV Charge Mode

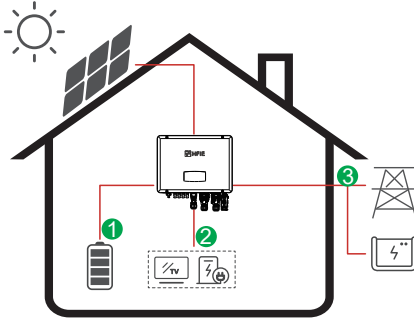

4 periods of time charge setting.

Energy flow:

PV → Battery → Load → Grid

AC Charging

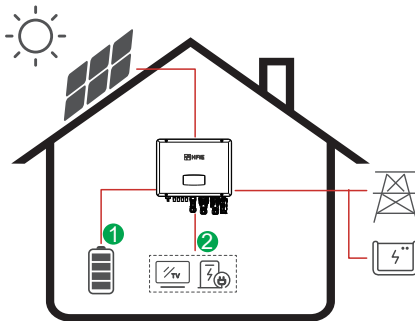

4 periods of time charge setting.

Energy flow:

PV and Grid → Battery → Load



Note:

After select AC charge, the AC will also charge the battery when the PV is low or no PV.

B. Forced Discharging

4 periods of time discharge setting

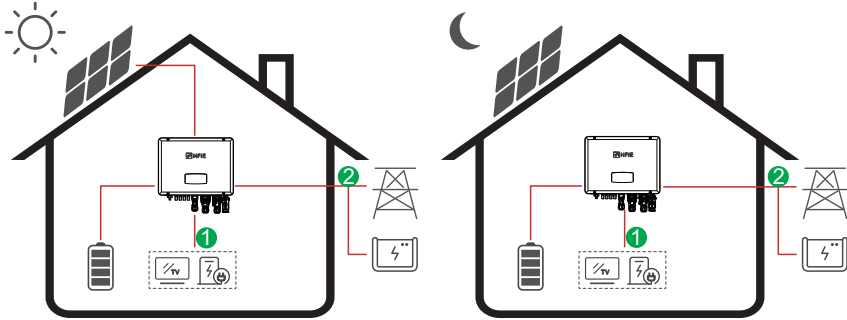

Energy flow: Battery and PV → Load → Grid

C. Forbidden Discharge

4 periods of time discharge setting, the battery will be charged firstly.

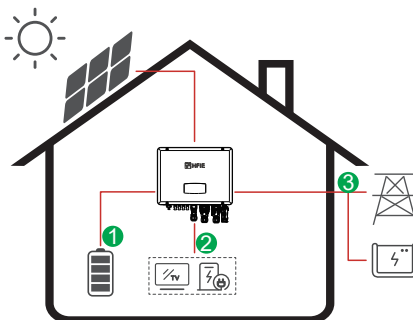

Energy flow:
PV → Battery → Load → Grid

4. Installation

4.1 Pre-installation

4.1.1 Unpacking & Package List

Unpacking

On receiving the inverter, please check to make sure the packing and all components are not missing or damaged. Please contact your dealer directly for supports if there is any damage or missing components.

Package List

Open the package, please check the packing list shown as below.

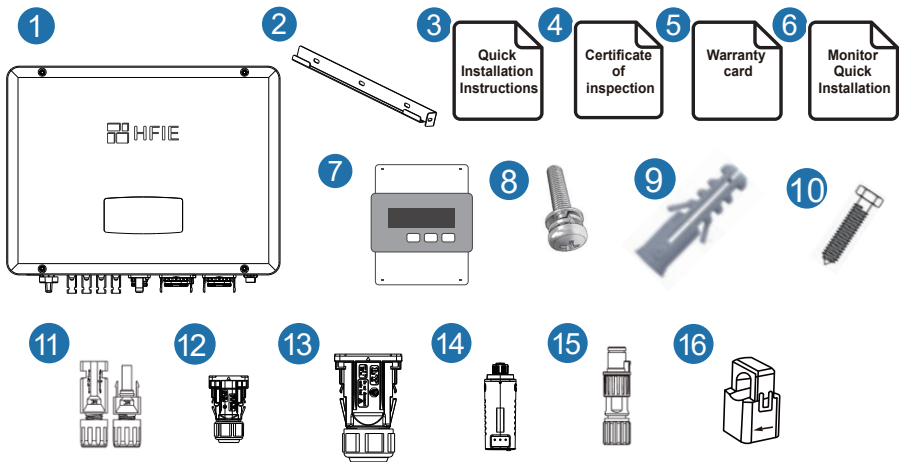

No.	Qty	Items	No.	Qty	Items
1	1	Hybrid Inverter	9	3	Expansion Tube
2	1	Wall Mounting Bracket	10	3	Bracket Screw
3	1	Quick Installation Instructions	11	4	PV Terminals
4	1	Inspection Certificate	12	1	Battery Terminals
5	1	Warranty Card	13	2	AC Terminals
6	1	Monitor Quick Installation	14	1	Monitor Module
7	1	Smart Meter	15	2	Zero-Injection Connector
8	1	Security Screw	16	3	CT (Optional)

4.1.2 Product Overview

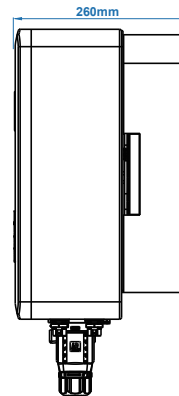
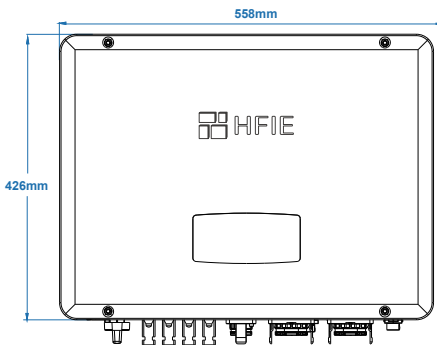

Inverter Terminals

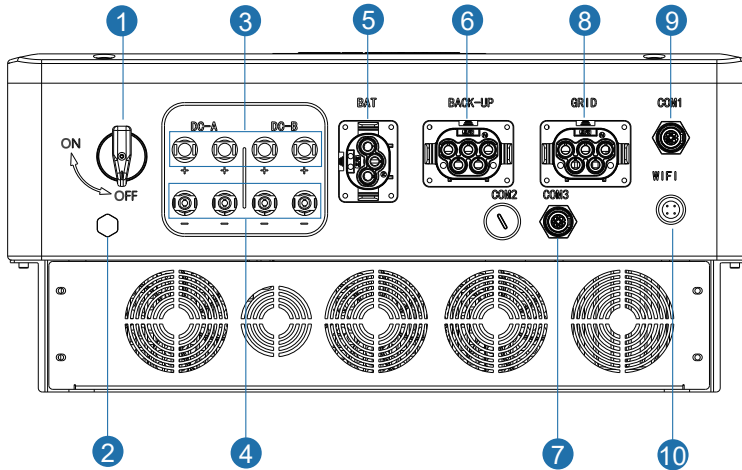

No.	Items	No.	Items
1	DC Switch	6	BACK UP
2	Waterproof Ventilating Valve	7	BAT Port
3	DC Connectors (+) For PV Strings	8	GRID UP
4	DC Connectors (-) For PV Strings	9	Meter Port
5	Battery Port	10	Wifi Port

4.1.3 Mounting Location

The inverters are designed for indoor and outdoor installation (IP65), to increase the safety, performance and lifespan of the inverter, please select the mounting location carefully based on the following rules:

- The inverter should be installed on a solid surface, far from flammable or corrosion materials, where is suitable for inverter's weight and dimensions.
- The ambient temperature should be within -25 C ~ 60 C (between -13 °F and 140°F).
- The installation of inverter should be protected under shelter. Do not expose the inverter to direct sunlight, water, rain, snow, spray lightning, etc.

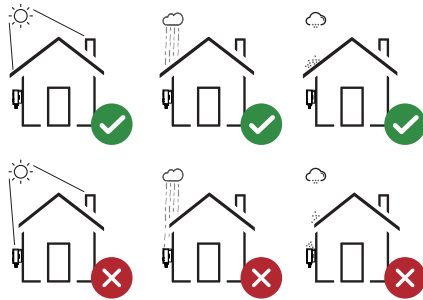

- The inverter should be installed vertically on the wall, or lean back on plane with a limited tilted angle. Please refer to below picture.

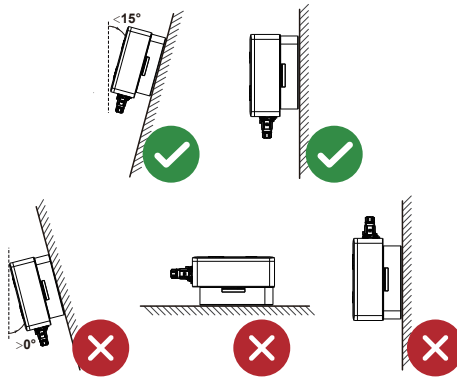

- Leave the enough space around inverter, easy for accessing to the inverter, connection points and maintenance.

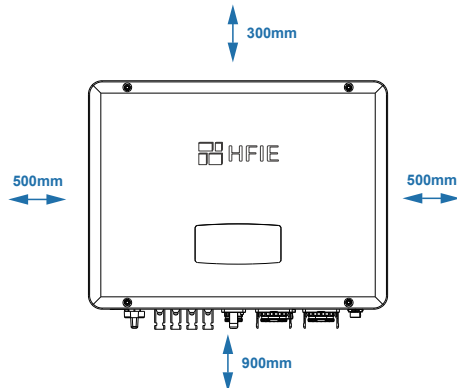

4.2 Mounting

Step 1

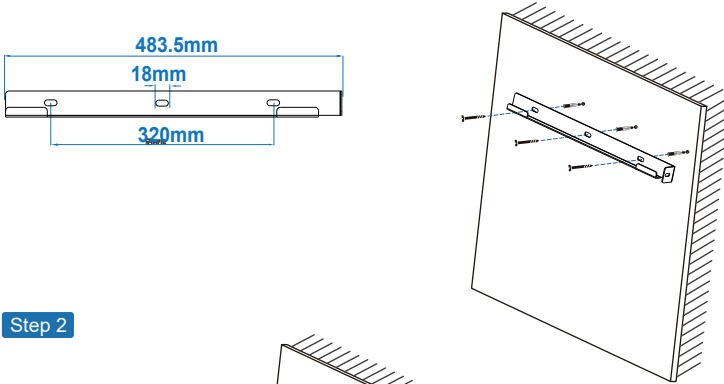

Step 2

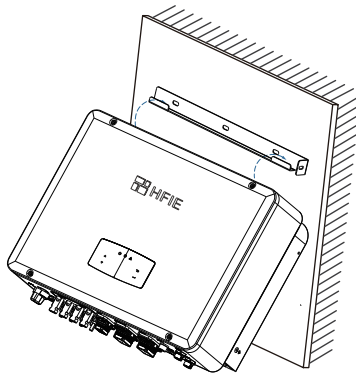

Step 3

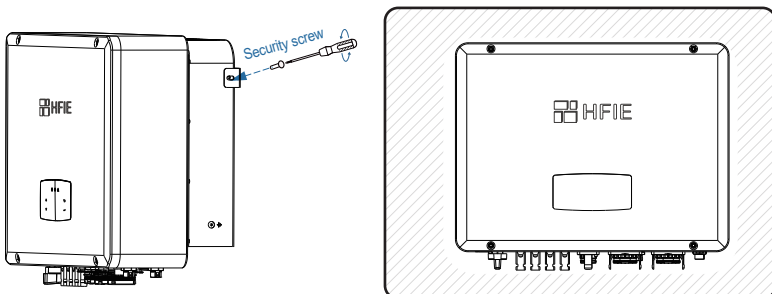

4.3 Electrical Connection

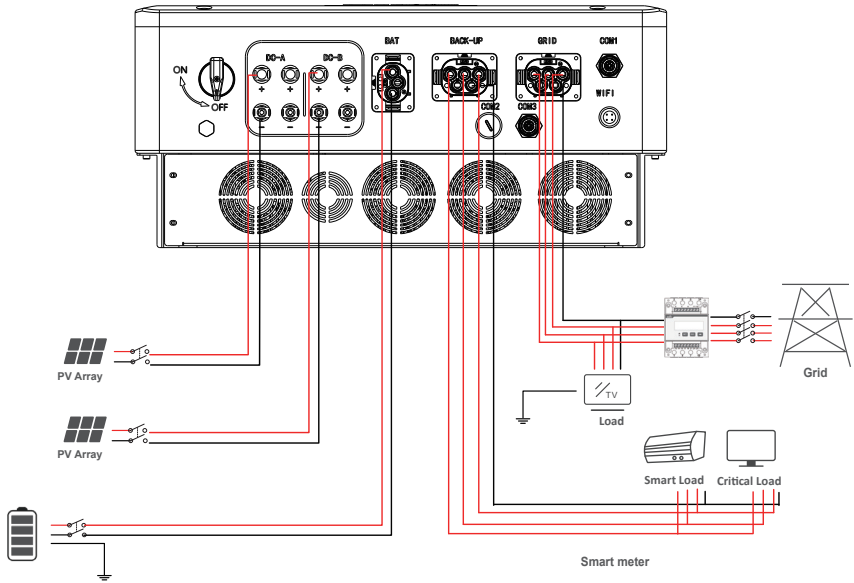

4.3.1 PV Connection

The AF-TH series hybrid inverter has one/two MPPT channels, can be connected with one/two strings of PV panels. Please make sure below requirements are followed before connecting PV panels and strings to the inverter:

- The open-circuit voltage and short-circuit current of PV string should not exceed the reasonable range of the inverters.
- The isolation resistance between PV string and ground should exceed 300 k Ω .
- The polarity of PV strings are correct.
- Use the DC plugs in the accessory.
- The lightning protector should be equipped between PV string and inverter.
- Disconnect all of the PV (DC) switch during wiring.



Warning:

The fatal high voltage may on the DC side, please comply with electric safety when connecting. Please make sure the correct polarity of the cable connected with inverter, otherwise inverter could be damaged.

Step 1

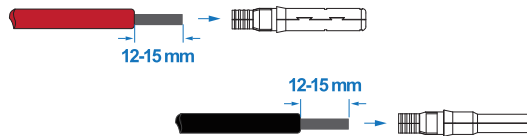

Note:

PV cable suggestion
Cross-section
4mm²

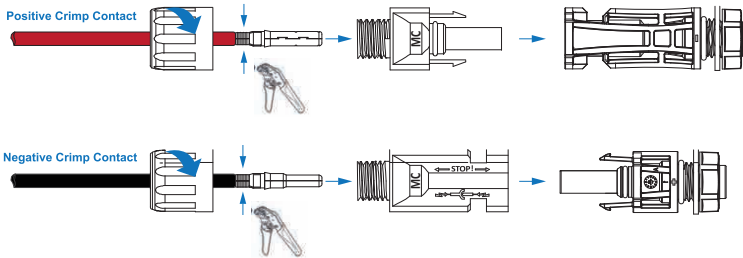
Step 2

Note:

Please use PV connector crimper to pinch the point of the arrow.

Note:

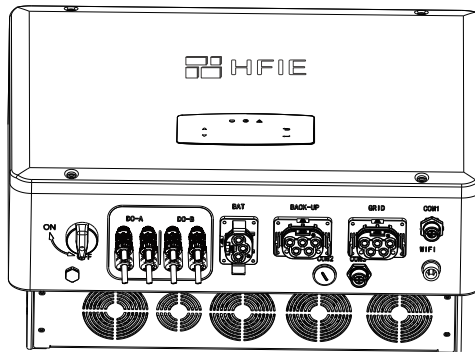
You'll hear click sound when the connector assembly is correct.

Step 3

4.3.2 Battery Connection

AF-TH series hybrid inverters are compatible with lithium battery. For lead acid battery or batteries with other brands, please confirm with local distributor or HFIE for technical support.

Note:

Set battery type and manufacturer, please refer to Chapter 5.3. BMS(Battery Management System)communication is needed between inverter and battery.

Step 1

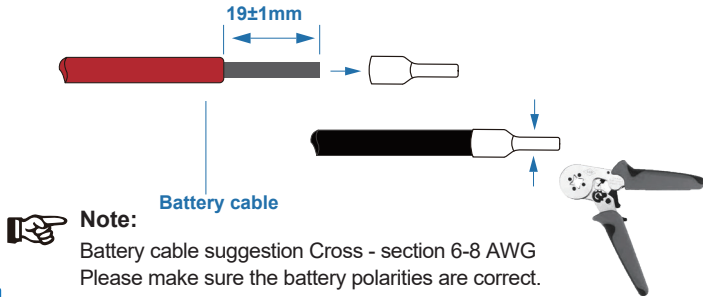

Step 2

Pass the crimped battery harness through the waterproof connector and the cover.

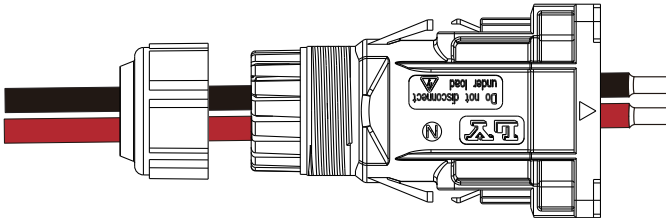

Step 3

Insert the wire harness into the terminals according to "+" and "-" polarity, make the insulated terminals parallel with the terminals, the crimping screw torque is $2.0 \pm 0.1 \text{ N.m}$

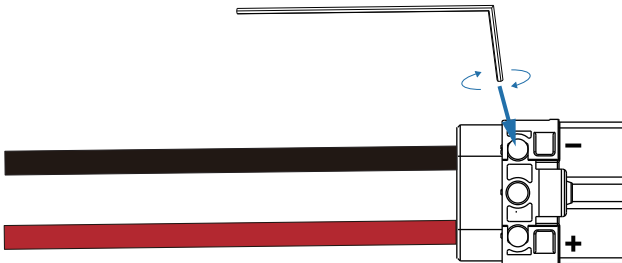

Step 4

A "click" sound will be heard when the connector assembly is correct.

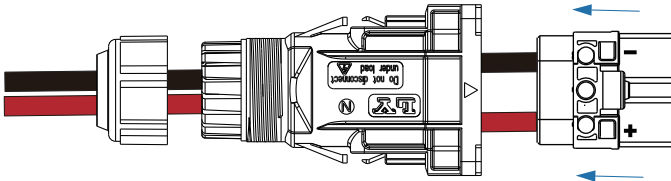
Step 5

Use an open-end wrench to tighten the waterproof lock.

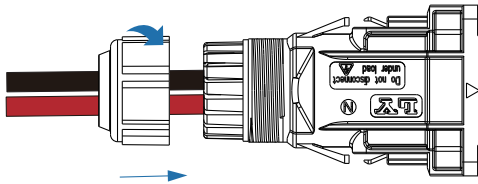
Step 6

Insert the battery connector into the inverter, if hear a "click", it means the battery connection is finished.

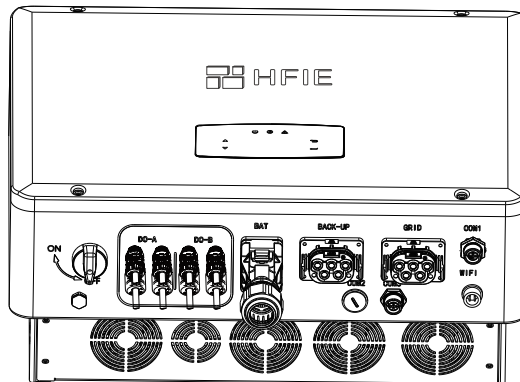

4.3.2.1 BAT-CAN/RS485

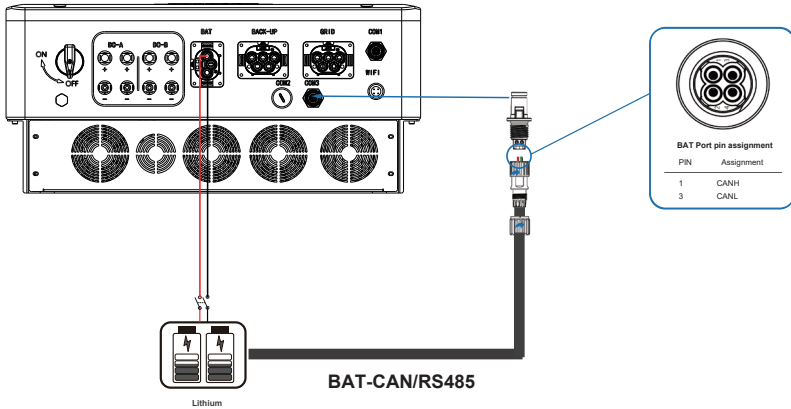

4.3.3 AC Connection

The AC terminal contains “GRID” and “BACK-UP”, GRID for load, and BACK-UP for emergency load.

Before connecting, a separate AC breaker between individual inverter and AC input power is necessary. This will ensure the inverter be securely disconnected during maintenance and fully protected from current of AC input.

An extra AC breaker is needed for On-Grid connection to be isolated from grid when necessary. Below are requirements for the On-Grid AC-breaker.

Inverter Model	AC breaker specification
AF3K~12K-TH	63A/230V/400V AC breaker
AF15~30K-TH	125A/230V/400V AC breaker



Note:

Qualified electrician will be required for the wiring.

Model	Wire Size	Cable (mm ²)	Torque value
3-30kW	8-10AWG	4-6	1.2N·m

Please follow steps for AC connection

- Connect DC protector or breaker first before connecting.
- remove insulation sleeve 11mm(0.5 inch) length, unscrew the bolts, insert the AC input wires according to polarities indicated on the terminal block and tighten the terminal screws.

Step 1

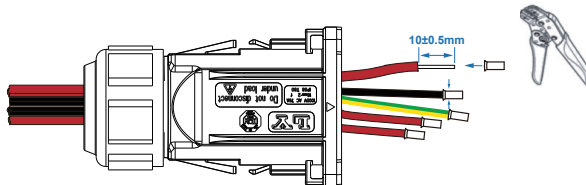

Note:

Cable suggestion: Cross-section 8-10AWG.

Earth cable PE suggestion: Cross-section (Copper) 8-10AWG

Note:
 The Max. power load connects to EPS port should not exceed the inverter's EPS Max. output power range.

Step 2

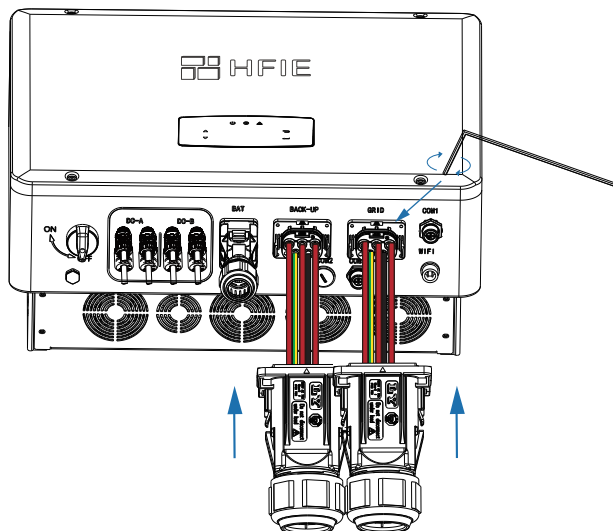

Step 3

Insert the connector into the inverter, if hear a “click”, it means the connection is finished.

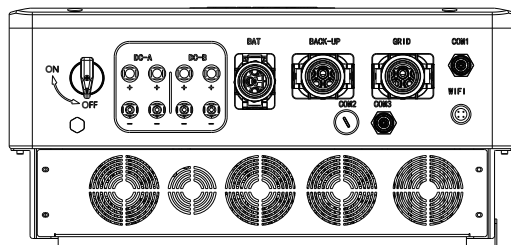

4.3.4 CT or Meter Connection

Meter and a current sensor(CT for short below) are used to detect current power direction of the local load and the grid. The output control function of the inverters will be activated based on the detected data.

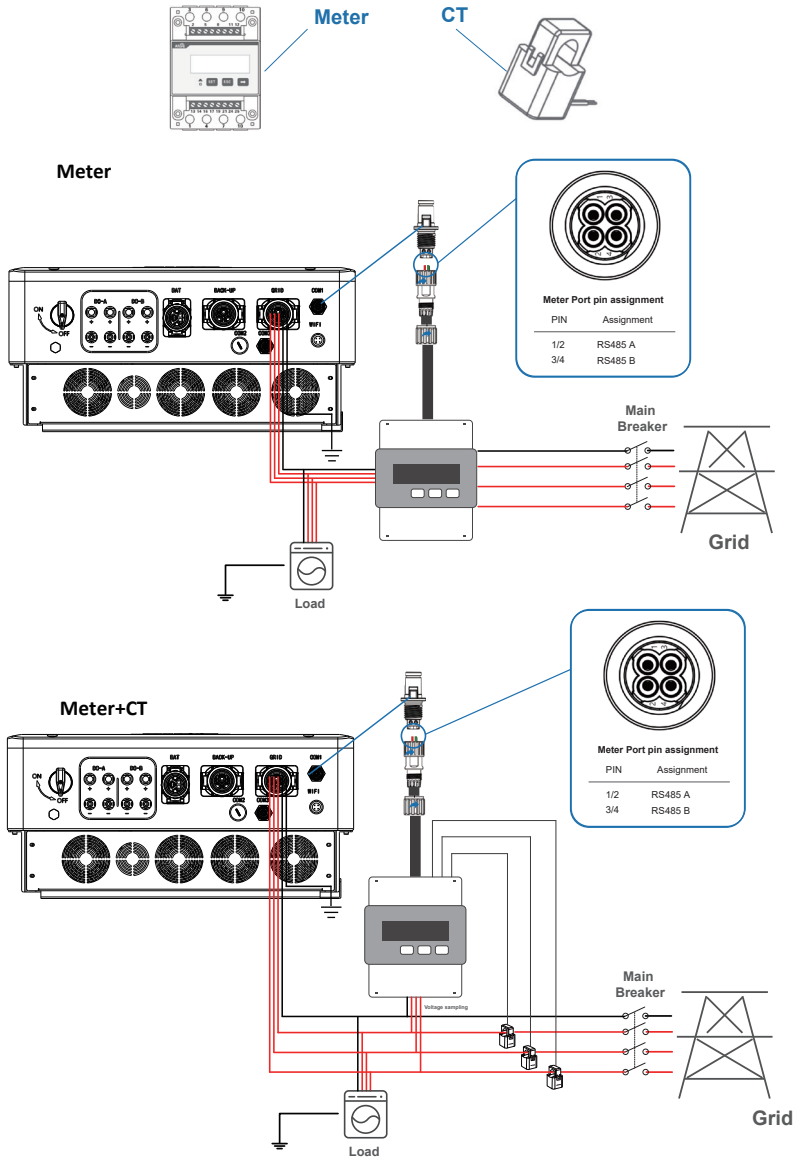

4.4 Communication Connection

The monitoring module could transmit the data to the cloud server, and display the data on the PC, tablet and smart-phone.

Install the WIFI / Ethernet / GPRS / RS485 Communication

WIFI / Ethernet / GPRS / RS485 communication is applicable to the inverter. Please refer to "Communication Configuration Instruction" for detailed instruction.

Step 1

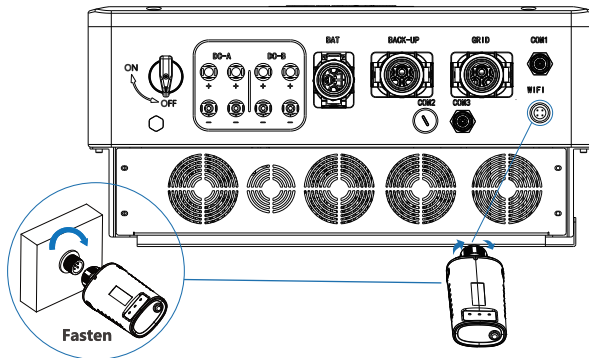

Step 2

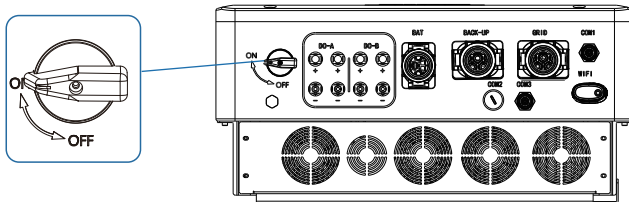



Turn on the DC switch and AC circuit breaker, and wait until the LED indicator on the monitoring module flashes, indicating that the monitoring module is successfully connected.

4.5 Earth Connection

Note:
 A second protective earth (PE) terminal should be connected to the inverter. This prevents electric shock if the original protective PE wire fails.

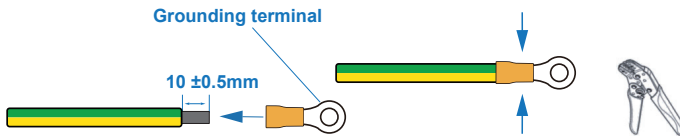
Step 1



Note:
 Earth cable PE suggestion:
 Cross-section (Copper) $4\text{-}6\text{mm}^2 / 10\text{AWG}$

Step 2

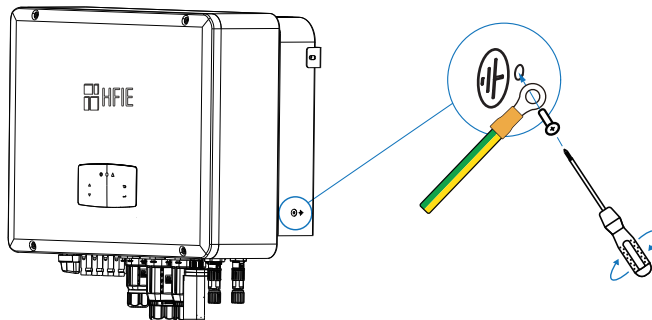

Fix the grounding screw to the grounding connection of the machine housing.

Note:
 Make sure the earth cables on the inverter and solar panel frame are separately.

4.6 Multi Inverter Parallel

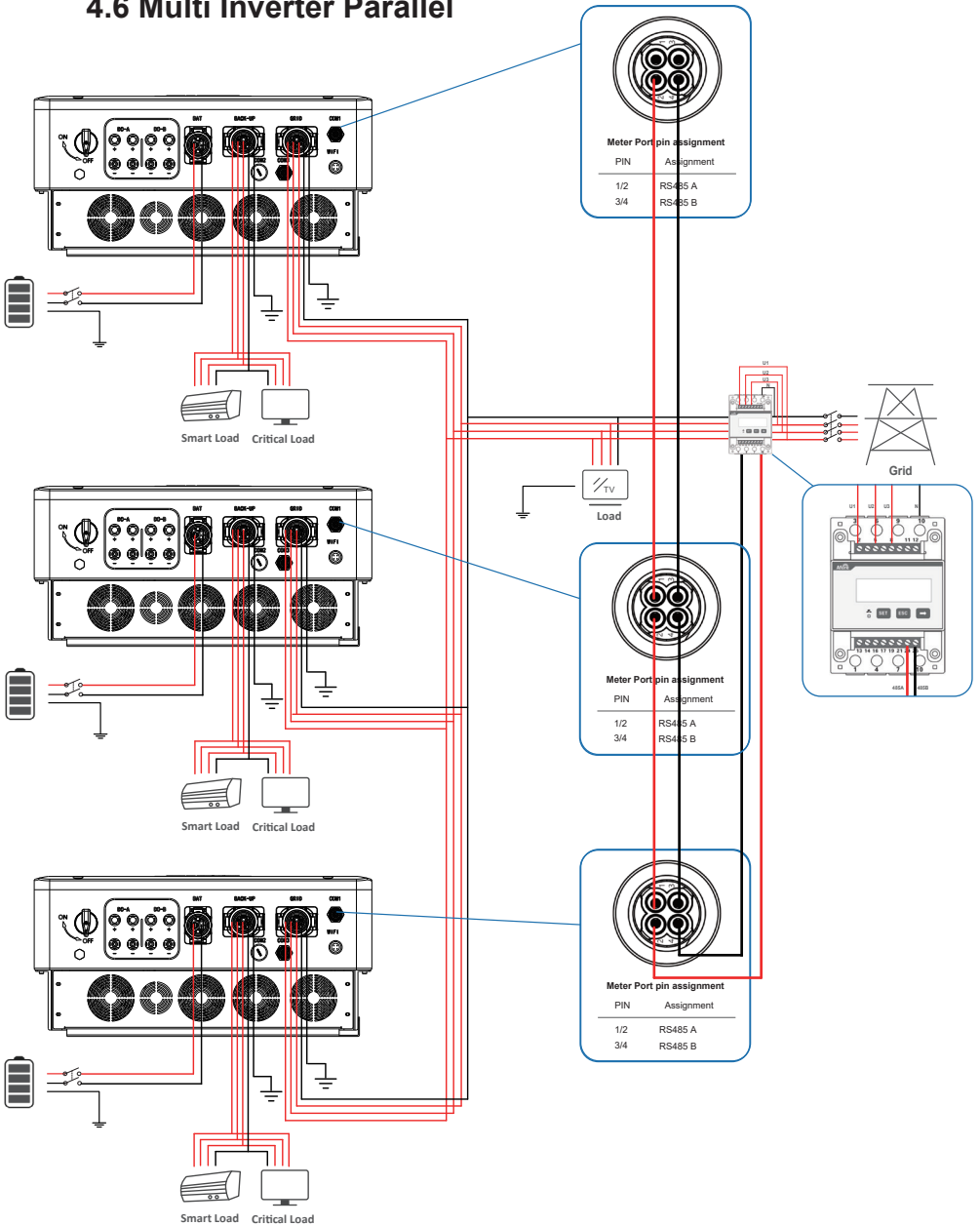

5. Operation

5.1 Control Panel

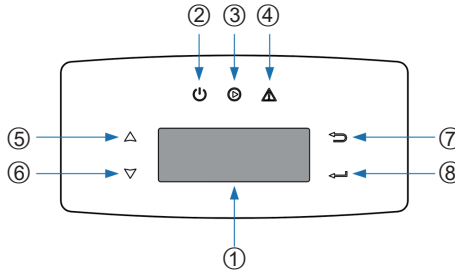

No.	Items	No.	Items
1	LCD Display	5	UP Touch Button
2	POWER LED Indicator	6	DOWN Touch Button
3	GRID LED Indicator	7	BACK Touch Button
4	FAULT LED Indicator	8	ENTER Touch Button

Note: Hold UP/DOWN button can be rolling quickly.

Sign	Power	Color	Explanation
POWER	ON	Green	The inverter is stand-by
	OFF		The inverter is power off
GRID	ON	Green	The inverter is feeding power
	OFF		The inverter is not feeding power
FAULT	ON	Red	Fault occurred
	OFF		No fault

5.2 Menu Overview

AF-TH hybrid inverter has a LCD for clearly operating, and menu of the LCD can be presented as following:

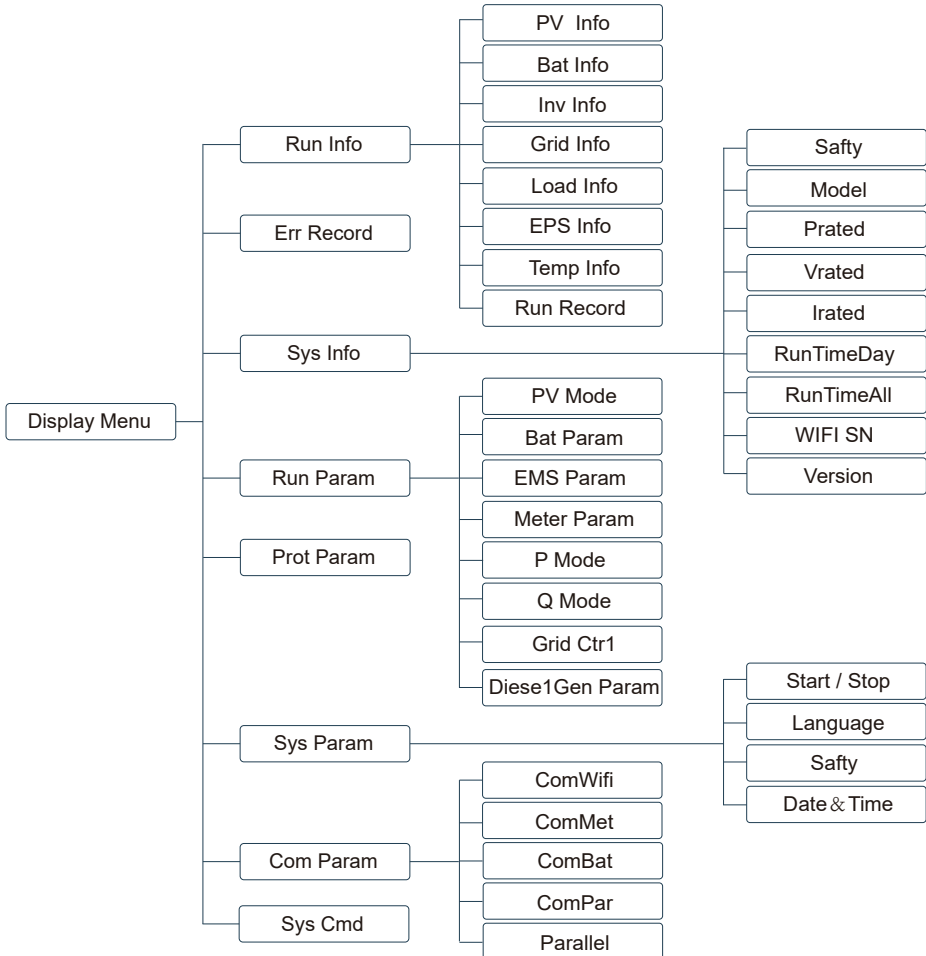

5.3 Inverter Setting

The setting is for AF-TH Hybrid inverter. Any doubts, please contact distributor for more details.

5.3.1 Time & Date

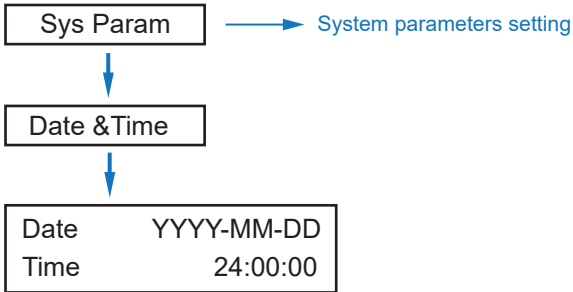

5.3.2 Safety

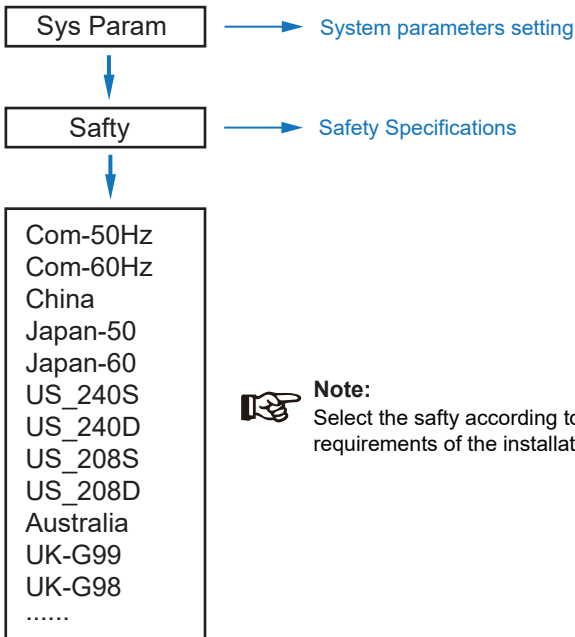

5.3.3 Lithium Battery

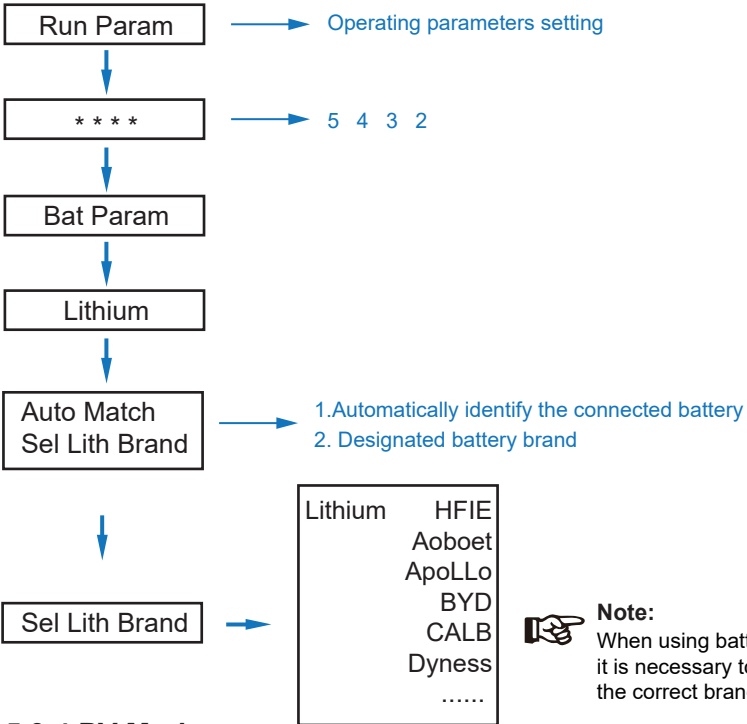

Note:

When using batteries, it is necessary to choose the correct brand.

5.3.4 PV Mode

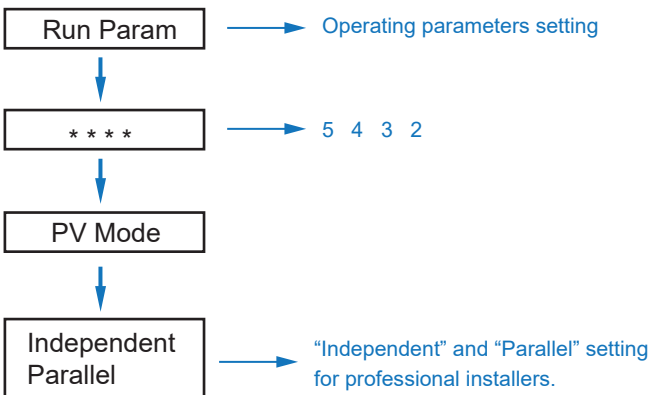

5.3.5 Lead Acid

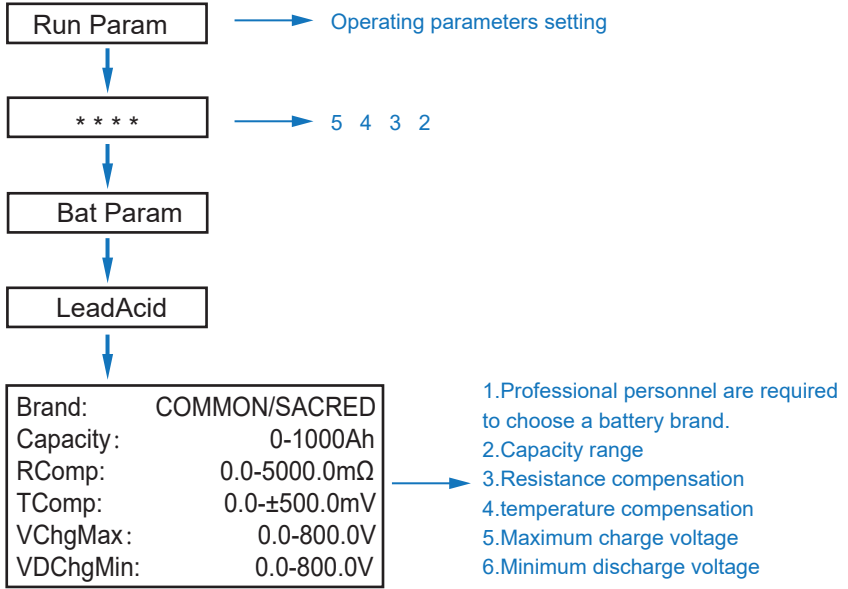

5.3.6 Energy Management System (EMS Param)

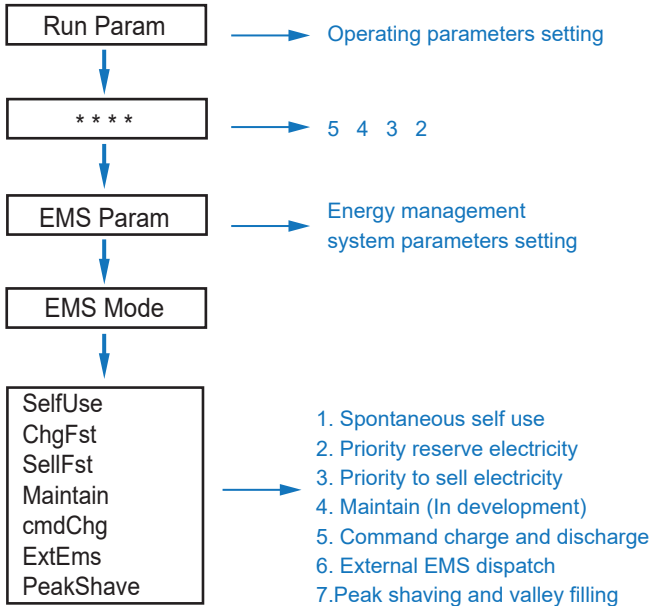

Note:

For detailed introduction of each mode, please refer to chapter 3.2 of the user manual.

5.3.7 Time of Use

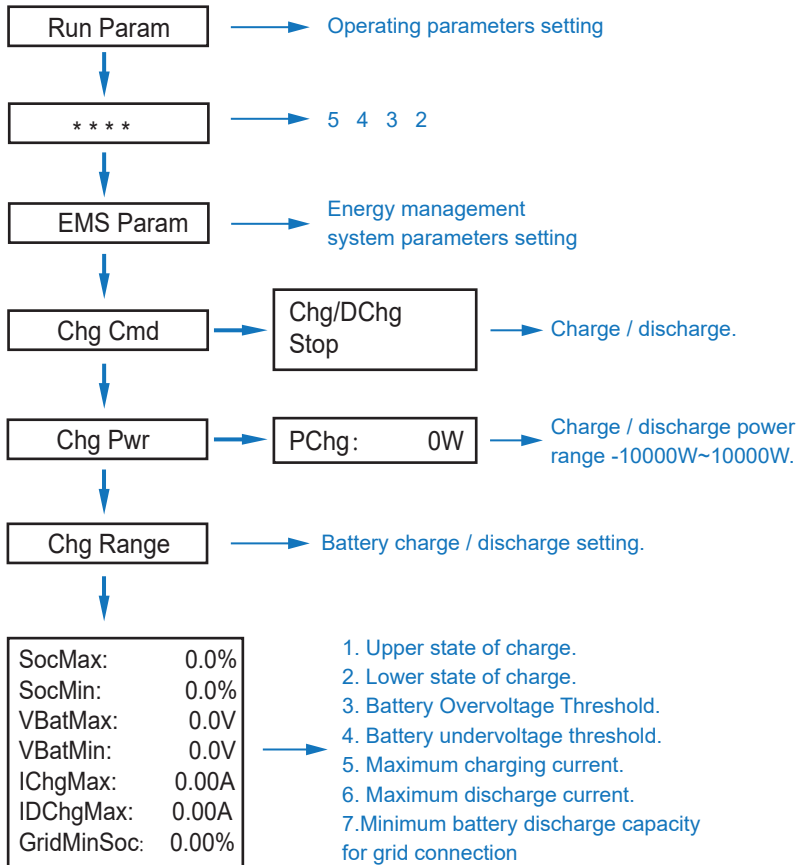

Note:

Timed charge and discharge need to complete the three settings of "Chg Cmd", "Chg Pwr" and "Chg Range", otherwise it will not work properly.

5.3.8 AC Charging

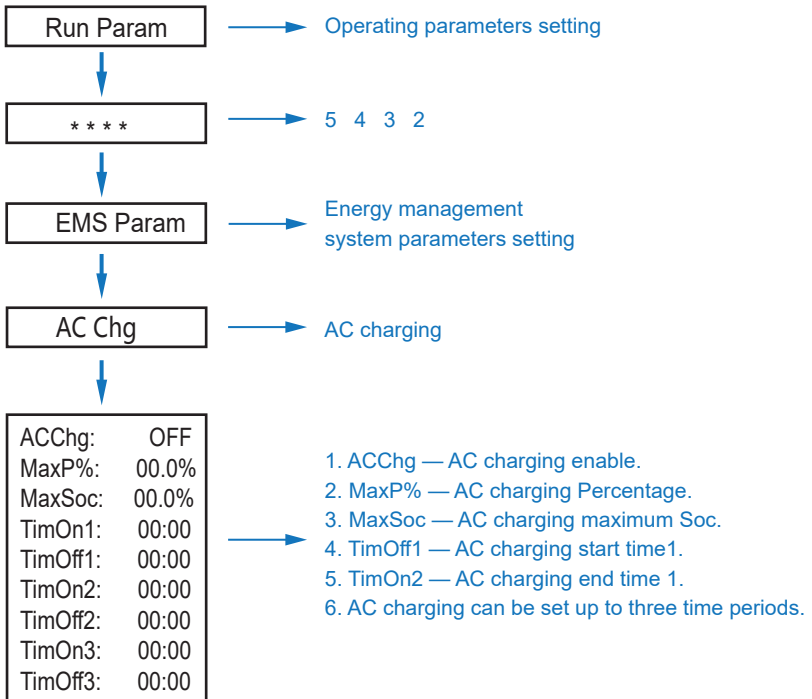

5.3.9 Forced Charging

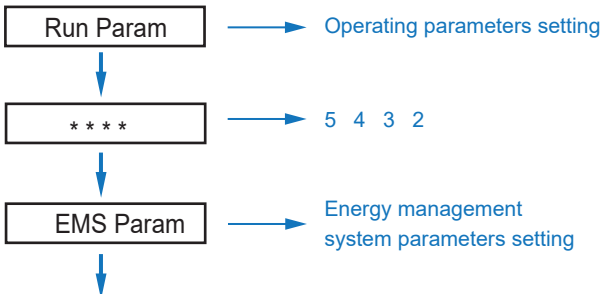

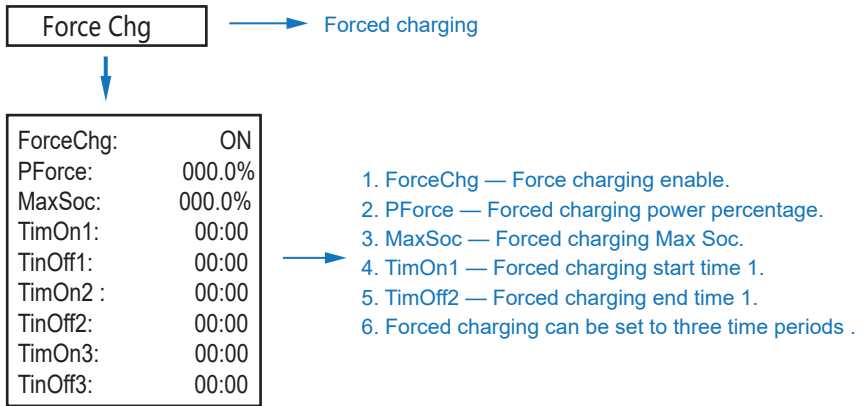

5.3.10 Forced Discharging

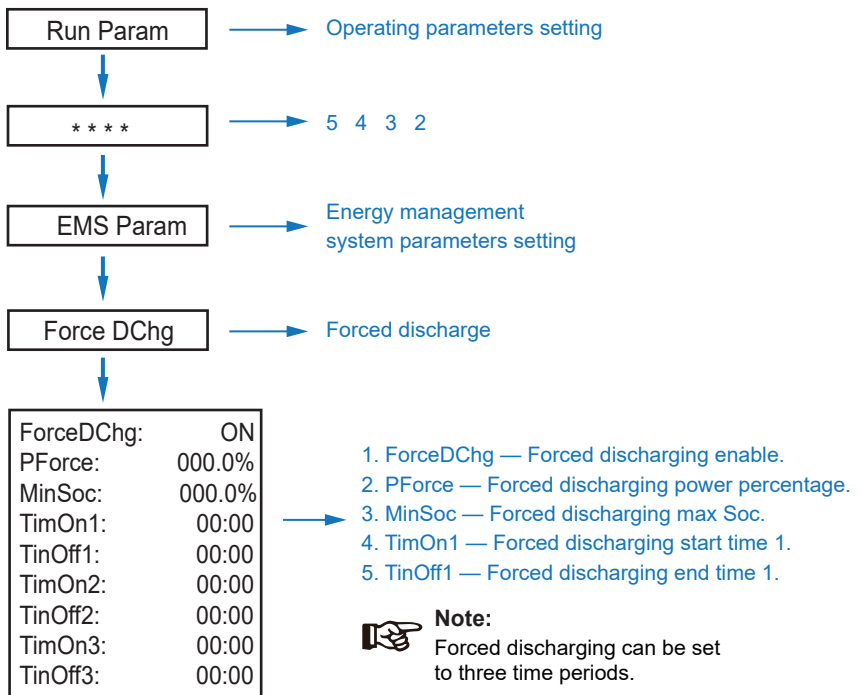

5.3.11 Protection Parameters

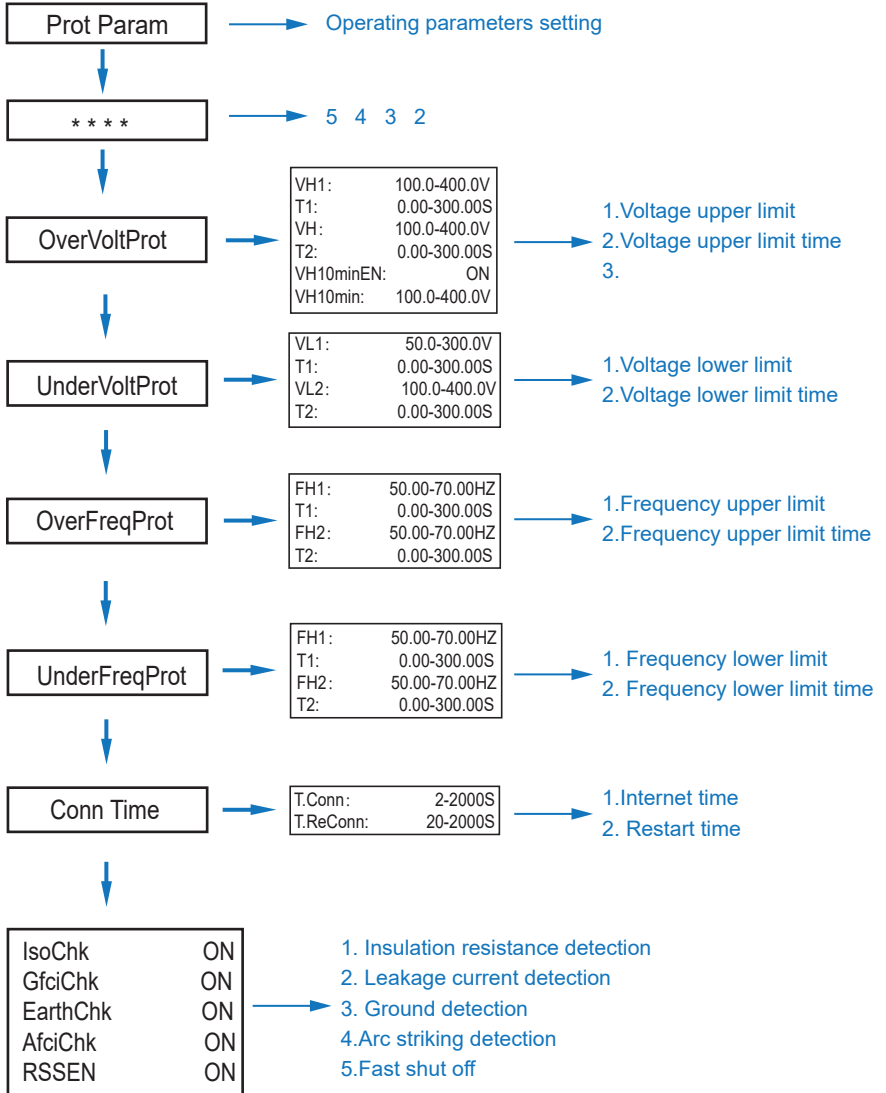

Note:

When modifying parameters, you need to pay attention to the unit.

5.3.12 Multi-machine in Parallel

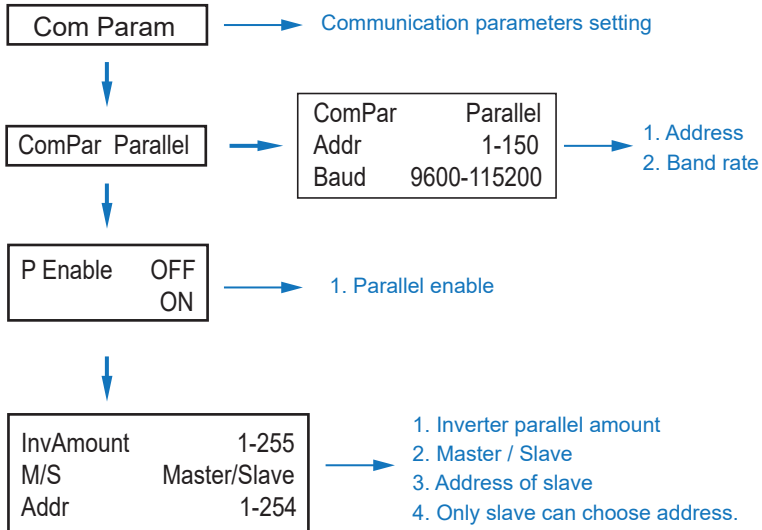

5.3.13 Diesel Generator Setting (Diese1 Gen Param)

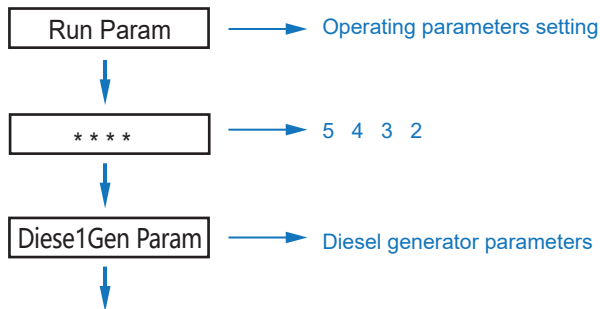

Diese1GenEn	ON
TimeCtr1En	ON
StartSoc	0.0-100.0%
EndSoc	0.0-100.0%
TimeDelay	0-1000S
TimOn1	00:00
TimOff1	00:00
TimOn2	00:00
TimOff2	00:00
TimOn3	00:00
TimOff3	00:00



1. Diese1GenEn — Diesel generator enable.
2. TimeCtr1En — Time control enable.
3. StarSoc — Battery power percentage when diesel generator start charging the battery.
4. EndSoc — Battery power percentage when diesel generator stop charging the battery.
5. TimeDelay — Delay time of diesel generator start working.
6. TimOn1 — Diesel generator start time 1.
7. TimOff1 — Diesel generator off time 2.



Note:

Diesel generator enable and time control enabled must be on, other wise the diesel generator can not be started.

6. Power ON/OFF

Please check the following requirements before testing:

- Installation location is suitable according to Chapter 4.1.3.
- All electrical wires are connected tightly, including PV modules, battery and AC side(Such as the grid side, EPS side, Gen side).
- Earth line and Smart meter/CT line are connected.
- AF-TH hybrid inverters should be set according to the required local grid standard.
- More information please contact with HFIE or distributors.

6.1 Power ON

- Turn on DC switch.
- After LCD lighting, hybrid inverter should be set following Chapter 5.3 at the first time.
- When inverter running under normal mode, Running indicator will light up(Ref. to Chapter 5.1).

6.2 Power OFF

- Turn off DC switch (in hybrid inverter) and all extra-breaker.

**Note:**

Hybrid inverter should be restarted after 5 minutes.

6.3 Restart

Restart Hybrid inverter, please follow steps as below:

- Shutdown the inverter Ref. to Chapter6.2.
- Start the inverter Ref. to Chapter 6.1.

7. Maintenance & Trouble Shooting

7.1 Maintenance

Periodically maintenance are necessary, please follow steps as below.

- PV connection: twice a year
- AC connection(Grid and EPS) : twice a year
- Battery connection: twice a year
- Earth connection: twice a year
- Heat sink: clean with dry towel once a year

7.2 Trouble Shooting

The fault messages are displayed when fault occurs, please check trouble shooting table and find related solutions.

Fault Code and Trouble Shooting

Type of Fault	Code	Name	Description	Recommend Solution
PV Fault	A01	PvConnectFault	PV connection type different from setup	<ul style="list-style-type: none"> • Check PV modules connection • Check PV Mode setup Ref. Chapter 5.3.
	A02	IsoFault	ISO check among PV panels/ wires and ground is abnormal.	<ul style="list-style-type: none"> • Check PV modules wires, those wires are soaked or damaged, and then carry out rectification. • If the fault occurs continuously and frequently, please ask help for local distributors.
	A03	PvAfcifault	PV current arcing	<ul style="list-style-type: none"> • Check PV modules wires and connectors broken or loose connect, and then carry out rectification. • If the fault occurs continuously and frequently, please ask help for local distributors.
	A04	Pv1OverVoltFault	PV Voltage over	<ul style="list-style-type: none"> • Reconfiguration of PV strings, reduce the PV number of a PV string to reducing inverter PV input voltage. • Suggestion that contacting with local distributors.
	A05	Pv2OverVoltFault		
	A06	Pv3OverVoltFault		
	A07	Pv4OverVoltFault		
	A08	Pv5OverVoltFault		
	A09	Pv6OverVoltFault		
	A10	Pv7OverVoltFault		
	A11	Pv8OverVoltFault		
	A12	Pv9OverVoltFault		
	A13	Pv10OverVoltFault		
	A14	Pv11OverVoltFault		
	A15	Pv12OverVoltFault		
	A16	PV1ReverseFault	PV(+) and PV(-) reversed Connection	<ul style="list-style-type: none"> • Check PV(+) and PV(-) Connect whether reversed or not. • If reversed, make correction.
	A17	PV2ReverseFault		
	A18	PV3ReverseFault		
	A19	PV4ReverseFault		
	A20	PV5ReverseFault		
	A21	PV6ReverseFault		

Type of Fault	Code	Name	Description	Recommend Solution
PV Fault	A22	PV7ReverseFault		
	A23	PV8ReverseFault		
	A24	PV9ReverseFault		
	A25	PV10ReverseFault		
	A26	PV11ReverseFault		
	A27	PV12ReverseFault		
	A33	Pv1AbnormalFault	PV(+) and PV(-) reversed Connection	<ul style="list-style-type: none"> • Check PV modules partial occlusion or cells damaged. • Check PV module wires and connectors broken or loose connect, then repair it.
	A34	Pv2AbnormalFault		
	A35	Pv3AbnormalFault		
	A36	Pv4AbnormalFault		
	A37	Pv5AbnormalFault		
	A38	Pv6AbnormalFault		
	A39	Pv7AbnormalFault		
	A40	Pv8AbnormalFault		
	A41	Pv9AbnormalFault		
	A42	Pv10AbnormalFault		
	A43	Pv11AbnormalFault		
	A44	Pv12AbnormalFault		
	A45	Pv13AbnormalFault		
	A46	Pv14AbnormalFault		
	A47	Pv15AbnormalFault		
	A48	Pv16AbnormalFault		
	A49	Pv17AbnormalFault		
	A50	Pv18AbnormalFault		
A51	Pv19AbnormalFault			
A52	Pv20AbnormalFault			
A53	Pv21AbnormalFault			
A54	Pv22AbnormalFault			
A55	Pv23AbnormalFault			
A56	Pv24AbnormalFault			

Type of Fault	Code	Name	Description	Recommend Solution
Battery Fault	B01	PcsBatOverVoltFault	Battery voltage over or under	<ul style="list-style-type: none"> • Check inverters connected battery lines and connectors broken or loose connect. • Carry out rectification if broken or loose. • Checking battery voltage is abnormal or not, then maintenance or change new battery.
	B02	PcsBatUnderVoltFault		
	B03	PcsBatInsOverVoltFaul		
	B04	PcsBatReversedFault	Bat. (+) and Bat. (-) are reversed.	<ul style="list-style-type: none"> • Check Bat.(+) and Bat.(-)connect reversed or not. • Make correction If reversed.
	B05	PcsBatConnectFault	Battery wires loose	<ul style="list-style-type: none"> • Check battery wires and connectors damage or loose connect. • Carry out rectification if break.
	B06	PcsBatComFault	Battery communication abnormal	<ul style="list-style-type: none"> • Check battery side communication wires damage or loose connect, and then carry out rectification. • Check battery is off or other abnormal, then Mastertenance battery or change new battery.
	B07	PcsBatTempSensorOpen	Battery temperature sensor abnormal	<ul style="list-style-type: none"> • Check battery temperature sensor and connected wires damage or not , then rectification or change new one.
	B08	PcsBatTempSensorShort		
	B09	BmsBatSystemFault	All these faults will be detected or reported by battery BMS.	<ul style="list-style-type: none"> • If specific fault high temperature or low temperature, then should change battery installed environment temperature. • Restart battery, maybe can working as normal. • If this fault occurs continuously and frequently, please ask help for local distributors.
	B10	BmsBatVolOverFault		
	B11	BmsBatVolUnderFault		
	B12	BmsCellVolOverFault		
	B13	BmsCellVolUnderFault		
	B14	BmsCellVolUnbanceFau		
	B15	BatChgCurOverFault		
	B16	BatDChgCurOverFault		
	B17	BatTemperatureOverFa		
	B18	BatTemperatureUnderF		
	B19	CelTemperatureOverFa		
	B20	CelTemperatureUnderF		
	B21	BatIsoFault		
	B22	BatSocLowFault		
	B23	BmsInterComFault		
	B24	BatRelayFault		

Type of Fault	Code	Name	Description	Recommend Solution
Battery Fault	B25	BatPreChaFault		
	B26	BmsBatChgMosFault		
	B27	BmsBatDChgMosFault		
	B28	BMSVolOVFault		
	B29	BMSVolLFault		
	B30	VolLockOpenFault		
	B31	VolLockShortFault		
	B32	ChgRefOVFault		
	C01	GridLossFault	Grid lost (islanding)	<ul style="list-style-type: none"> Inverter will restart automatically when the grid return to normal. Check inverter connected with grid connectors and cable normal or not.
	C02	GridUnbalanVoltFault	Grid Voltage unbalanced.	<ul style="list-style-type: none"> The inverter will restart automatically when the grid three phase return to normal. Check inverter connected with the grid connectors and wires normal or not. connectors and cable normal or not.
	C03	GridInstOverVoltFault	Grid instantaneous voltage over	<ul style="list-style-type: none"> The inverter will restart automatically when the grid three phase return to normal. Contact with local distributor or required grid company adjust protection parameters.
	C04	Grid10MinOverVoltFault	Grid voltage Over by 10 Minutes	<ul style="list-style-type: none"> The inverter will restart automatically when the grid three phase return to normal. Contact with local distributor or required grid company adjust 10 minutes protection voltage parameters.
	C05	GridOverVoltFault	Grid voltage over	<ul style="list-style-type: none"> The inverter will restart automatically when the grid three phase return to normal. Contact with local distributor or required grid company adjust voltage protection parameters.
	C06	GridUnderVoltFault	Grid voltage under	
	C07	GridLineOverVoltFault	Grid line voltage over	
	C08	GridLineUnderVoltFault	Grid line voltage under	
	C09	GridOverFreqFault	Grid Frequency over	<ul style="list-style-type: none"> The inverter will restart automatically when the grid three phase return to normal. Contact with local distributor or required grid company adjust frequency protection parameters.
C10	GridUnderFreqFault	Grid Frequency under		

Type of Fault	Code	Name	Description	Recommend Solution
Off-grid Fault	D01	UpsOverPowerFault	Off-grid load over	<ul style="list-style-type: none"> • Reduce loads. • If sometimes overload, it can be ignored, when generation power enough can be recovery. • If those faults occurs continuously and frequently, please ask help for local distributors.
	D02	GridConflictFault	Grid connected to Back-up terminal	<ul style="list-style-type: none"> • Check the off-grid port connection correct, disconnect both off-grid and grid ports.
	D03	GenOverVoltFault	GenOverVoltFault	<ul style="list-style-type: none"> • Adjust generator running parameters, make the output voltage, frequency in allowed range. • If this fault occurs continuously and frequently, please ask help for local distributors.
	D04	GenUnderVoltFault	GenUnderVoltFault	
	D05	GenOverFreqFault	GenOverFreqFault	
	D06	GenUnderFreqFault	GenUnderFreqFault	
DC Fault	E01		PV current over, triggered by hardware protection circuit	<ul style="list-style-type: none"> • Power off, then restart (Ref. Chapter8). • If those faults occurs continuously and frequently, please ask help for local distributors.
	E02			
	E03			
	E04			
	E05			
	E06			
	E07			
	E08			
	E09			
	E10		PV current over, triggered by Software logic.	<ul style="list-style-type: none"> • Power off, power on then restart. • If those faults occurs continuously and frequently, please ask help for local distributors.
	E11			
	E12			
	E13			
	E14			
E15				
E16				
E17				
E18				
E19				
E20				

Type of Fault	Code	Name	Description	Recommend Solution
DC Fault	E21	Pv9SwOverCurrFault		
	E22	Pv10SwOverCurrFault		
	E23	Pv11SwOverCurrFault		
	E24	Pv12SwOverCurrFault		
	E33	Boost1SelfCheck(boost)Fault	PV boost circuit abnormal when self checking	<ul style="list-style-type: none"> • Power off, then restart (Ref. Chapter8). • If those faults continuously and frequently, please ask help for local distributors.
	E34	Boost2SelfCheck(boost)Fault		
	E35	Boost3SelfCheck(boost)Fault		
	E36	Boost4SelfCheck(boost)Fault		
	E37	Boost5SelfCheck(boost)Fault		
	E38	Boost6SelfCheck(boost)Fault		
	E39	Boost7SelfCheck(boost)Fault		
	E40	Boost8SelfCheck(boost)Fault		
	E41	Boost9SelfCheck(boost)Fault		
	E42	Boost10SelfCheck(boost)Fault		
	E43	Boost11SelfCheck(boost)Fault		
	E44	Boost12SelfCheck(boost)Fault		
	E45	BusHwOverVoltFault	Bus voltage over	<ul style="list-style-type: none"> • Power off, then restart (Ref. Chapter8). • If those faults continuously and frequently, please ask help for local distributors.
	E46	BusHwOverHalfVoltFault		
	E47	BusSwOverVoltFault		
	E48	BusSwOverHalfVoltFault		
	E49	BusSwUnderVoltFault	Bus voltage under as running	
	E50	BusUnbalancedFault	DC Bus voltage unbalanced	
	E51	BusBalBridgeHwOver-CurFault	Bus Controller current over	<ul style="list-style-type: none"> • Power off, then restart (Ref. Chapter8). • If those faults continuously and frequently, please ask help for local distributors.
	E52	BusBalBridgeSwOver-CurFault		
	E53	BusBalBridgeSelf-CheckFault	Bus Controller abnormal when self checking	
	E54	BDChwOverCurrFault	BiDC current over	<ul style="list-style-type: none"> • Power off, then restart (Ref. Chapter8). • If those faults continuously and frequently, please ask help for local distributors.
	E55	BDCSwOverCurrFault		
	E56	BDCSelfCheckFault	BiDC abnormal as self checking	
E57	BDCSwOverVoltFault	BiDC voltage over		
E58	TransHwOverCurrFault	BiDC current over		

Type of Fault	Code	Name	Description	Recommend Solution
	E59	BDCFuseFault	BiDC fuse broken	<ul style="list-style-type: none"> • Change fuse.
	E60	BDCRelayFault	BiDC relay abnormal	<ul style="list-style-type: none"> • Power off, then restart (Ref. Chapter8). • If those faults continuously and frequently, please ask help for local distributors.
AC Fault	F01	HwOverFault	All over current/ voltage by protection hardware	<ul style="list-style-type: none"> • Power off, then restart (Ref. Chapter8). • If those faults occurs continuously and frequently, please ask help for local distributors.
	F02	InvHwOverCurrFault	Ac over current by protection hardware	
	F03	InvROverCurrFault	R phase current over	
	F04	InvSOverCurrFault	S phase current over	
	F05	InvTOverCurrFault	T phase current over	
	F06	GridUnbalanCurrFault	On-grid current unbalanced	
	F07	DcInjOverCurrFault	DC injection current over	
	F08	AcOverLeakCurrFault	Ac side leakage current over	<ul style="list-style-type: none"> • Check AC insulation and ground wires connect ground is well or not, then repair it. • Power off, then restart (Ref. Chapter8).. • If those fault occurs continuously and frequently, please ask help for local distributors.
	F09	PLLFault	PLL abnormal	<ul style="list-style-type: none"> • Power off, then restart (Ref. Chapter8). • If those fault occurs continuously and frequently, please ask help for local distributors.
	F10	GridRelayFault	Grid relay abnormal	
	F11	UpsRelayFault	Ups relay abnormal	
	F12	GenRelayFault	Generator relay abnormal	
	F13	Relay4Fault	Relay4 abnormal	
	F14	UpsROverCurrFault	Off-grid output current over	<ul style="list-style-type: none"> • When off-grid the load start impulse current is over, reduce the start impulse current load. • Power off, then restart (Ref. Chapter8). • If those fault occurs continuously and frequently, please ask help for local distributors.
	F15	UpsSOverCurrFault		
	F16	UpsTOverCurrFault		
	F17	GenROverCurrFault	Generator current over	<ul style="list-style-type: none"> • Check generator output voltage, frequency is stability, and adjust generator. • Power off, then restart(Ref. Chapter8). • If those fault occurs continuously and frequently, please ask help for local distributors.
	F18	GenSOverCurrFault		
	F19	GenTOverCurrFault		
	F20	GenReversePowerFault		

Type of Fault	Code	Name	Description	Recommend Solution
AC Fault	F21	UpsOverVoltFault	Off-grid output voltage over or under	<ul style="list-style-type: none"> • Power off, then restart (Ref. Chapter8). • If those faults occurs continuously and frequently, please ask help for local distributors.
	F22	UpsUnderVoltFault		
	F23	UpsOverFreqFault	Off-grid output frequency over or under	
	F24	UpsUnderFreqFault		
	F25	DcInjOverVoltFault	Off-grid DC injection voltage over	
System Fault	G01	PV1CurAdChanFault	Sampling hardware abnormal	<ul style="list-style-type: none"> • Power off, then restart (Ref. Chapter8). • If those faults occurs continuously and frequently, please ask help for local distributors.
	G02	PV2CurAdChanFault		
	G03	PV3CurAdChanFault		
	G04	PV4CurAdChanFault		
	G05	PV5CurAdChanFault		
	G06	PV6CurAdChanFault		
	G07	PV7CurAdChanFault		
	G08	PV8CurAdChanFault		
	G09	PV9CurAdChanFault		
	G10	PV10CurAdChanFault		
	G11	PV11CurAdChanFault		
	G12	PV12CurAdChanFault		
	G13	BDCCurrAdChanFault		
	G14	TransCurAdChanFault		
	G15	BalBrigCurAdChanFault		
	G16	RInvCurAdChanFault		
	G17	SInvCurAdChanFault		
	G18	TInvCurAdChanFault		
	G19	RInvDciAdChanFault		
	G20	SInvDciAdChanFault		
	G21	TInvDciAdChanFault		
	G22	LeakCurAdChanFault		
	G23	VoltRefAdChanFault		
	G24	UpsRCurAdChanFault		

Type of Fault	Code	Name	Description	Recommend Solution
System Fault	G25	UpsSCurAdChanFault		
	G26	UpsTCurAdChanFault		
	G27	GenRCurAdChanFault		
	G28	GenSCurAdChanFault		
	G29	GenTCurAdChanFault		
	G30	UpsRDcvAdChanFault		
	G31	UpsSDcvAdChanFault		
	G32	UpsTDcvAdChanFault		
	G37	TempAdChanFault	All temperature sensors abnormal	
	G38	VoltAdConflictFault	The sample value of PV, battery and BUS voltage inconsistent	<ul style="list-style-type: none"> • Power off, then restart (Ref. Chapter8). • If those faults occurs continuously and frequently, please ask help for local distributors.
	G39	CPUAdConflictFault	The sample value between master CPU and slaver CPU inconsistent	
	G40	PowerCalcConflictFault	Power value between PV, battery and AC output inconsistent	
	G41	EnvirOverTempFault	Installation environment temperature over or low	<ul style="list-style-type: none"> • Change or improve the installation environment temperature, make running temperature suitable. • Power off, then restart (Ref. Chapter8). • If those faults occurs continuously and frequently, please ask help for local distributors.
	G42	EnvirLowTempFault		
	G43	CoolingOverTempFault	Cooling temperature over or low	
	G44	CoolingLowTempFault		
	G45	OverTemp3Fault	Temperature3 over or low	
	G46	LowTemp3Fault		
G47	CpuOverTempFault	CPU temperature over		
G48	ModelConflictFault	Version conflict with inverter	<ul style="list-style-type: none"> • Power off, then restart (Ref. Chapter8). • If those faults occurs continuously and frequently, please ask help for local distributors. 	
	H01	PVCurrOverErr	PV current overload	
	H02	BdcCurrOverErr	DBC current overload	
	H03	InvCurrOverErr	Inversion current overload	

Type of Fault	Code	Name	Description	Recommend Solution
Permanent Fault	H04	UpsCurrOverErr	off-grid current overload	<ul style="list-style-type: none"> • if abnormal, repair or change. • Power off, then restart (Ref. Chapter8). • If those faults occurs continuously and frequently, please ask help for local distributors.
	H05	GenCurrOverErr	Generator current overload	
	H06	DclnjCurrErr	DC component of the grid connected current exceeds the maximum value	
	H07	DclnjVoltErr	DC component of the off grid voltage exceeds the maximum value	
	H08	BusAllVoltSwOveErr	BUS voltage exceeds maximum value	
	H09	RelayErr	Relay malfunction	
	H10	PvBoostSelfChckErr	PV boost self-test fault	
	H11	BDCSelfChkPermErr	BDC self-test fault	
	H12	InvOpenTestErr	Inverter self-test fault	
Inner Warning	I01	InterFanWarning	Fan abnormal	<ul style="list-style-type: none"> • Remove foreign matter logged in fan. • If those faults occurs continuously and frequently, please ask help for local distributors.
	I02	ExterFanWarning		
	I03	Fan3Warning		
	I04	EnvirTempAdChanWarning	Some temperature sensors abnormal	<ul style="list-style-type: none"> • The warnings are not matter influence. • Power off, then restart (Ref. Chapter8). • If those faults occurs continuously and frequently, please ask help for local distributors.
	I05	CoolingTempAdChanWarning		
	I06	Temp3AdChanWarning		
	I07	ExtFlashComWarning	Flash abnormal	<ul style="list-style-type: none"> • Power off, then restart (Ref. Chapter8). • If this those faults continuously and frequently, please ask help for local distributors.
	I08	EepromComWarning	Eeprom abnormal	
	I09	SlaveComWarning	Communication between slaver CPU and master CPU abnormal	
	I10	HmiComWarning	HMI abnormal	
	I11	FreqCalcConflictWarning	Frequency value abnormal	
		I12	UnsetModel	Running model is not initial

Type of Fault	Code	Name	Description	Recommend Solution
Outside Warning	I13	ArcComWarning	Arc pulling communication failure	<ul style="list-style-type: none"> • Power off, then restart (Ref. Chapter8). • If this those faults continuously and frequently, please ask help for local distributors.
	I14	DspUpdate Fail	DSP upgrade failed	
	I15	OldTestPwrWarning	Abnormal aging power	
	I16	PhsAbnormal	Abnormal phase sequence	
	I17	Fan2Warning	Fan 2 alarm	
	J01	MeterComWarning	Meter/CT abnormal	<ul style="list-style-type: none"> • Check the smart meter model, connection or connectors are correct, any loose. • if abnormal, repair or change. • Power off, then restart (Ref. Chapter8). • If those faults occurs continuously and frequently, please ask help for local distributors.
	J02	MeterConnectWarning	Wires connecting type of meter wrong	<ul style="list-style-type: none"> • Check Meter/CT connection, installed place, and installed direction. • if abnormal, re-installation. • Power off, then restart (Ref. Chapter8). • If this those faults continuously and frequently, please ask help for local distributors.
	J03	SohWarning	Battery SOH low	<ul style="list-style-type: none"> • Contact with Battery manufacturer.
	J04	GndAbnormalWarning	Earth impedance over by cable loose and so on	<ul style="list-style-type: none"> • Check earth line connection or earth connecting impedance. • if abnormal, then adjust it. • Power off, then restart (Ref. Chapter8). • If this those faults continuously and frequently, please ask help for local distributors.
	J05	ParallelComWarning	Communication between master inverter and slaver ones abnormal in parallel mode	<ul style="list-style-type: none"> • Check parallel connect communication wires damage, connectors loose, connect port correct or not. • if not, then adjust it. • Power off, then restart (Ref. Chapter8). • If this those faults continuously and frequently, please ask help for local distributors.

Type of Fault	Code	Name	Description	Recommend Solution
Permanent Fault	J06	PVOverVoltWarning	PV voltage overvoltage alarm	<ul style="list-style-type: none"> • Check the PV input voltage. • Adjusting the number of connected photovoltaic panels. • Power off, then restart (Ref. Chapter8). • If this those faults continuously and frequently, please ask help for local distributors.
	J07	Meter2ComWarning	Abnormal communication of auxiliary electricity meter	<ul style="list-style-type: none"> • Check the smart meter model, connection or connectors are correct, any loose. • if abnormal, repair or change. • Power off, then restart (Ref. Chapter8). • If those faults occurs continuously and frequently, please ask help for local distributors.
	J08	ParaComErr	Inverter parallel communication fault	<ul style="list-style-type: none"> • Check if the communication port connection or connector is correct and not loose. • if abnormal, repair or change. • Power off, then restart (Ref. Chapter8). • If those faults occurs continuously and frequently, please ask help for local distributors.
	J09	ParaComWarning	Inverter parallel communication alarm	
	J10	MeterDataAbnormal	Abnormal electricity meter data	<ul style="list-style-type: none"> • Check the smart meter / CT model, connection or connectors are correct, any loose. • if abnormal, repair or change. • Power off, then restart (Ref. Chapter8). • If those faults occurs continuously and frequently, please ask help for local distributors.
	J11	CTDirectionErr	CT direction error	
	J12	Bat Activate Fail	Battery activation failed	<ul style="list-style-type: none"> • Check the smart battery model, connection or connectors are correct, any loose. • if abnormal, repair or change. • Power off, then restart (Ref. Chapter8). • If those faults occurs continuously and frequently, please ask help for local distributors.
	J13	BatSocLowWarning	Low battery SOC alarm	<ul style="list-style-type: none"> • Check the battery level in a timely manner and charge the battery. • Power off, then restart (Ref. Chapter8). • If those faults occurs continuously and frequently, please ask help for local distributors.

8. Specifications

PV Input	AF3K-TH	AF4K-TH	AF5K-TH	AF6K-TH	AF8K-TH	AF10K-TH
Max. DC Input Power (kW)	5	6	7.5	9	12	15
Max. PV Voltage (V)	1000					
Rated DC Input Voltage (V)	620					
DC Input Voltage Range (V)	150-1000					
MPPT Voltage Range (V)	150-850					
Full MPPT Range(V)	200-850		250-850		300-850	500-850
Start-up Voltage (V)	160					
Max. DC Input Current (A)	20x2					
Max. Short Current(A)	30x2					
No. of MPPT Tracker / Strings	2/2					
Battery Port						
Battery Nominal Voltage (V)	200	200	200	250	300	400
Battery Voltage Range (V)	150-800					
Max. Charge/Discharge Current (A)	30					
Max. Charge/Discharge Power (W)	3K	4K	5K	6K	8K	10K
Charging Curve	3 Stages					
Compatible Battery Type	Li-ion / Lead-acid					
AC Grid Output	AF3K-TH	AF4K-TH	AF5K-TH	AF6K-TH	AF8K-TH	AF10K-TH
Nominal AC Output Power (VA)	3000	4000	5000	6000	8000	10000
Max. AC Input Power	4500	6000	7500	9000	12000	15000
Max. AC Output Current (A)	5.3	7	8.5	10.5	13.5	17
Nominal AC Voltage (V)	230/400					
Nominal AC Frequency (Hz)	50/60					
Power Factor	1 (-0.8-0.8)					
Current THD (%)	< 3%					
AC Load Output (Back-up)						
Nominal Output Power (VA)	3000	4000	5000	6000	8000	10000
Nominal Output Voltage (V)	230/400					
Nominal Output Frequency (Hz)	50/60					
Nominal Output Current (A)	4.4	5.8	7.3	8.7	11.6	14.5
Peak Output Power	3300VA, 60s	4400VA, 60s	5500VA, 60s	6600VA, 60s	8800VA, 60s	11000VA, 60s
THDV (with linear load)	< 3%					
Switching Time (ms)	< 10					
Efficiency	AF3K-TH	AF4K-TH	AF5K-TH	AF6K-TH	AF8K-TH	AF10K-TH
Europe Efficiency	97.50%					
Max. Efficiency	98.00%			98.20%		
Battery Charge/Discharge Efficiency	98.00%					
Protection						
Reverse Polarity Protection	Yes					
Over Current / Voltage Protection	Yes					
Anti-islanding Protection	Yes					
AC Short-circuit Protection	Yes					
Leakage Current Detection	Yes					
Ground Fault Monitoring	Yes					
Grid Monitoring	Yes					
Enclosure Protect Level	IP65					
General Data	AF3K-TH	AF4K-TH	AF5K-TH	AF6K-TH	AF8K-TH	AF10K-TH
Dimensions (H x W x D) (mm)	558 x 535 x 260 mm					
Weight (kg)	26kg					
Topology	Transformerless					
Cooling Concept	Natural Convection				Intelligent Fan	
Relatively Humidity	0-100%					
Operating Temperature Range (°C)	-25 to 60 °C					
Operating Altitude (m)	<4000					
Noise Emission (dB)	< 30					
Standby Consumption (W)	< 5					
Display & Communication Interfaces	LCD, LED, RS485, CAN, Wi-Fi, GPRS, 4G					
Certification & Approvals	NRS97, G98/G99, EN50549-1, C10/C11, AS 4777, VDE-AR-N4105, VDE0126, IEC62040, IEC62109-1, IEC62109-2					
EMC	EN61000-6-2, EN61000-6-3					

PV Input	AF12K-TH	AF15K-TH	AF17K-TH	AF20K-TH	AF25K-TH	AF30K-TH
Max. DC Input Power (kW)	18	22.5	25.5	30	37.5	45
Max. PV Voltage (V)	1000					
Rated DC Input Voltage (V)	620					
DC Input Voltage Range (V)	150-1000					
MPPT Voltage Range (V)	150-850					
Full MPPT Range(V)	500-850					
Start-up Voltage (V)	160					
Max. DC Input Current (A)	20x2	20+32	32x2			40x2
Max. Short Current(A)	30x2	30+48	48x2			60x2
No. of MPPT Tracker / Strings	2/2	2/3	2/4			2/4
Battery Port						
Battery Nominal Voltage (V)	450	500	400	500	500	550
Battery Voltage Range (V)	150-800					
Max. Charge/Discharge Current (A)	30	50	50	50	60	60
Max. Charge/Discharge Power (W)	12K	15K	17K	20K	25K	30K
Charging Curve	3 Stages					
Compatible Battery Type	Li-ion / Lead-acid					
AC Grid Output	AF12K-TH	AF15K-TH	AF17K-TH	AF20K-TH	AF25K-TH	AF30K-TH
Nominal AC Output Power (VA)	12000	15000	17000	20000	25000	30000
Max. AC Input Power	18000	22500	25500	30000	37500	45000
Max. AC Output Current (A)	21.5	27	30	32	40	48
Nominal AC Voltage (V)	230/400					
Nominal AC Frequency (Hz)	50/60					
Power Factor	1 (-0.8-0.8)					
Current THD (%)	<3%					
AC Load Output (Back-up)						
Nominal Output Power (VA)	12000	15000	17000	20000	25000	30000
Nominal Output Voltage (V)	230/400					
Nominal Output Frequency (Hz)	50/60					
Nominal Output Current (A)	17.4	21.8	24.8	29	36.3	43.5
Peak Output Power	13200VA, 60s	16500VA, 60s	18700VA, 60s	22000VA, 60s	27500VA, 60s	33000VA, 60s
THDV (with linear load)	<3%					
Switching Time (ms)	<10					
Efficiency	AF12K-TH	AF15K-TH	AF17K-TH	AF20K-TH	AF25K-TH	AF30K-TH
Europe Efficiency	97.50%		97.80%		98.00%	98.10%
Max. Efficiency	98.30%		98.00%		98.50%	
Battery Charge/Discharge Efficiency	98.00%					
Protection						
Reverse Polarity Protection	Yes					
Over Current / Voltage Protection	Yes					
Anti-islanding Protection	Yes					
AC Short-circuit Protection	Yes					
Leakage Current Detection	Yes					
Ground Fault Monitoring	Yes					
Grid Monitoring	Yes					
Enclosure Protect Level	IP65					
General Data	AF12K-TH	AF15K-TH	AF17K-TH	AF20K-TH	AF25K-TH	AF30K-TH
Dimensions (H x W x D) (mm)	558 x 535 x 260 mm					
Weight (kg)	29kg			36kg		
Topology	Transformerless					
Cooling Concept	Intelligent Fan					
Relatively Humidity	0-100%					
Operating Temperature Range (°C)	-25 to 60 °C					
Operating Altitude (m)	<4000					
Noise Emission (dB)	<30			<40		
Standby Consumption (W)	<5					
Display & Communication Interfaces	LCD, LED, RS485, CAN, Wi-Fi, GPRS, 4G					
Certification & Approvals	NRS97, G98/G99, EN50549-1, C10/C11, AS 4777, VDE-AR-N4105, VDE0126, IEC62040, IEC62109-1, IEC62109-2					
EMC	EN61000-6-2, EN61000-6-3					